

No ceiling tile cutting,
Easy and Fast installation,
Save your Time, Effort and Cost.

Drop Ceiling Speaker - SQUARE

Innovative horn design that reduces the audio interference and provides incredible cover range. Equally diffuse the full range, high fidelity music in a sizable space



Available in White, Silver and Black to match your décor.

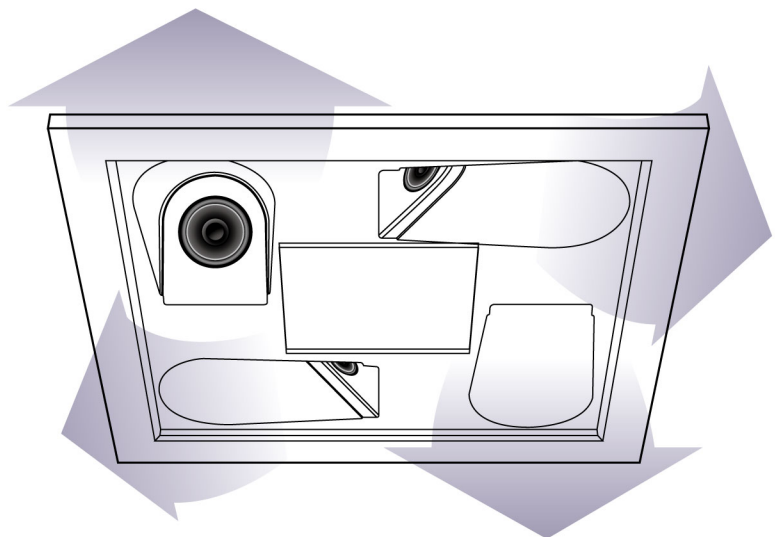

Distribute by

Traditional ceiling speaker arrangement and its coverage

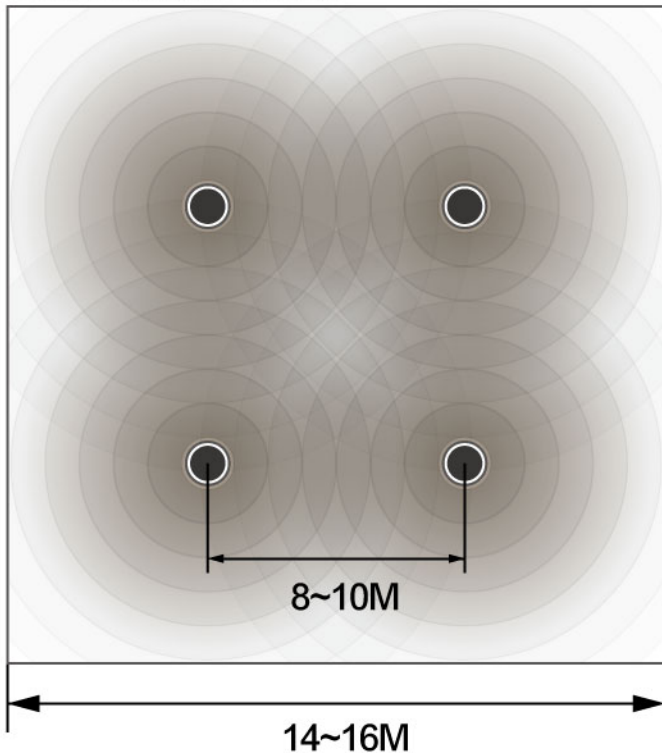

The innovative design of Square that substantially increase the diffusion and coverage

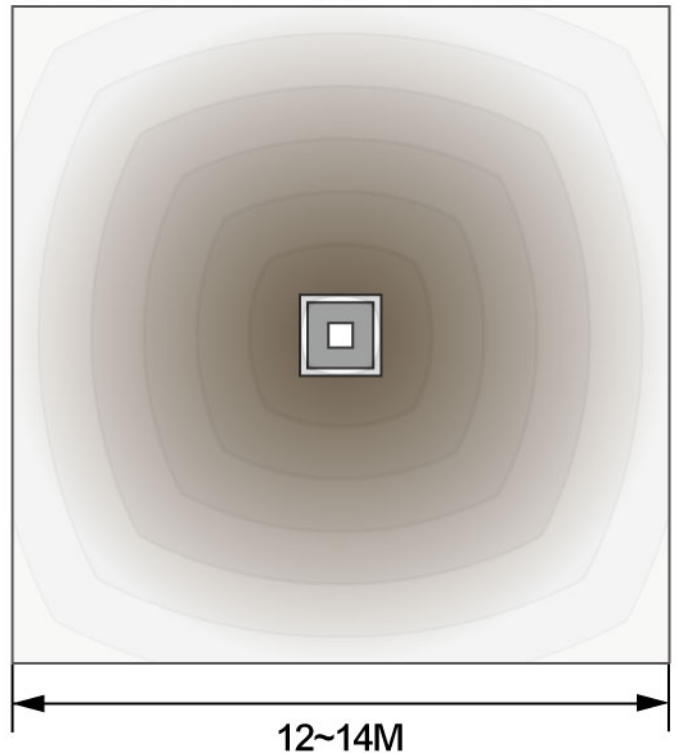

Traditional ceiling:
Limited coverage and diffusion.

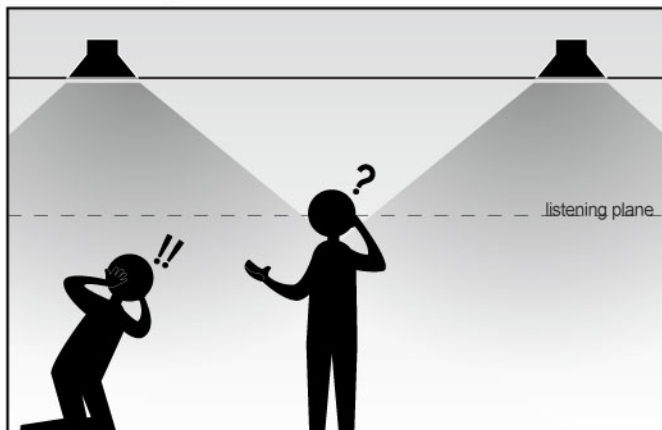

Drop ceiling speaker: Huge coverage and great diffusion for the full range of music.

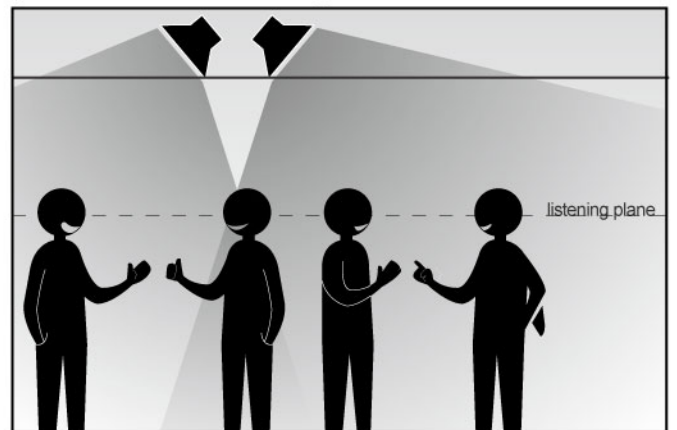

Save works when renewing ceiling tile

The life cycle of the usual ceiling tile is 4~5 years. It will get dirty and weak when getting old and the speakers on it may have the potential risk of falling. When renewing the ceiling, you have to remove the speakers and re-install them on the new tile if you choose them as your music/PA speaker. The Square installs on the ceilingframe which is the strongest part of the suspended ceiling. With this design you can wave all these concerns aside.

Four Independent cabinet design that helps to avoid interference and dust

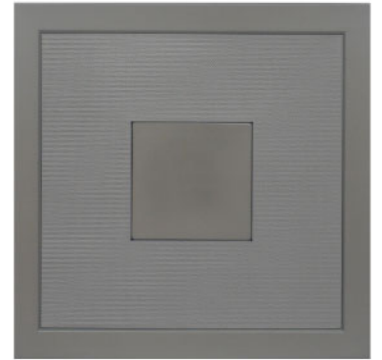
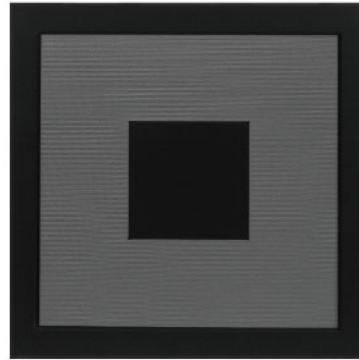
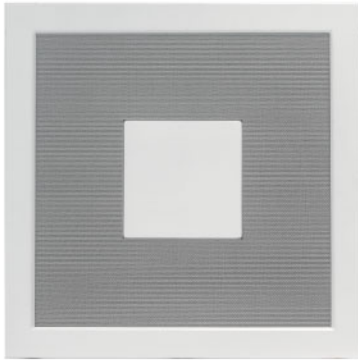

SQ - 4W

SQ - 4B

SQ - 4S

Model No.	SQ - 4W	SQ - 4B	SQ - 4S
Rated Power(RMS)	30W		
Impedance	80hm		
SPL (1W / 1M)	89dB		
Freq. Range(+/-10dB)	100Hz~20KHZ		
Dimension (H x W x D) mm	605 x 605 x 125		
Material	Panel : ABS ; Grille : steel		
Color	White	Black	Silver
N. W.	6kg/unit		
G. W.	7kg/unit		
Package	4units/mater carton		
Accessory	EVA stickers x 4		

Installation Manual



1. Take off the paper cover on the EVA sticker
2. Stick the EVA on the suspended ceiling's frame edge
3. Connect the cable to the terminal of the speaker, and place the speaker on the frame.

